

stûv

S [16]

The
essential
fire

Remarkable for its width, the s16 range stands out for its pure lines. Its powerful, cleverly-designed models offer a wide view of the fire, and quickly radiate an enveloping warmth. Their varied configurations and dimensions mean they can be integrated into the most varied of environments.

wood-burning insert

appliance to be integrated
into a wall or chimney breast



s[16]in p.2

wood-burning stoves

freestanding appliance that requires
no finishing work to install

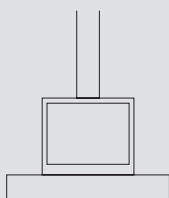

s[16]cube p.12

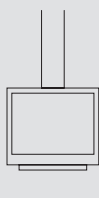

s[16]up p.20

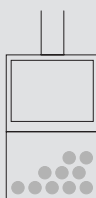

s[16]H p.28

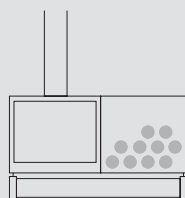

s[16]D4 p.36







Choosing Stûv means opting for quality and simplicity.

s[16]in

58

68

78

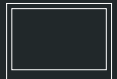

The s16-in is a wood insert designed to fit easily into an existing fireplace opening.

The different frames available give it a neat finish.

Performance*

Energy efficiency class

Energy efficiency index

Output

Output range

Nominal efficiency

Seasonal efficiency

Fine particle emissions

CO emissions

NOx emissions

COV/COG emissions



Range of wood consumption

s[16]in

Logs - Maximum length

Weight

Standards

A	A	A
103	102	99
7 kW	7,5 kW	8 kW
5 - 8 kW	5 - 9 kW	6 - 10 kW
78 %	77 %	75 %
68 %	68 %	65 %
11 mg/Nm ³	19 mg/Nm ³	13 mg/Nm ³
0,09 %	0,10 %	0,09 %
134 mg/Nm ³	117 mg/Nm ³	130 mg/Nm ³
89 mg/Nm ³	59 mg/Nm ³	94 mg/Nm ³
1,4 - 2,3 kg/h	1,5 - 2,6 kg/h	1,8 - 3,0 kg/h
58	68	78
		
40 cm	50 cm	60 cm
91 kg	102 kg	112 kg
EcoDesign 2022	EcoDesign 2022	EcoDesign 2022

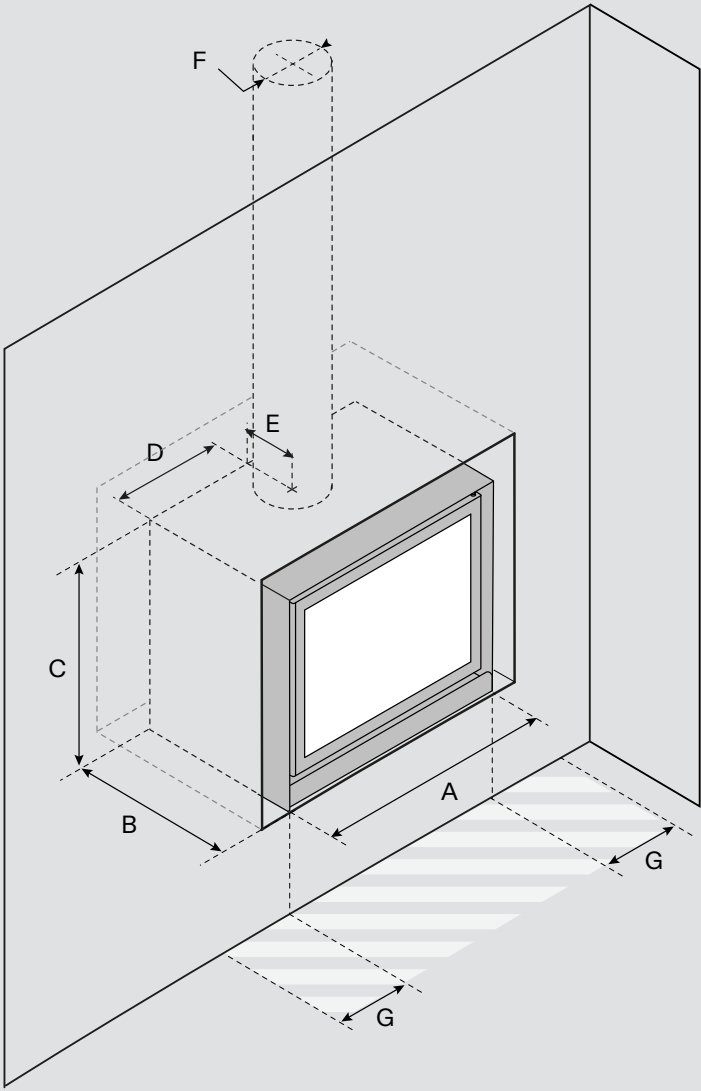

s[16]in

	58	68	78
[A] Width	580 mm*	680 mm*	780 mm*
[B] Depth	440 mm*	440 mm*	440 mm*
[C] Height	610 mm*	610 mm*	610 mm*
[D] Flue axis - side	290 mm	340 mm	390 mm
[E] Flue axis - rear	114 mm	114 mm	114 mm
[F] Smoke outlet diameter	180 mm	180 mm	180 mm
[G] Minimum side clearance	250 mm	150 mm	150 mm
Ø External air connection	63 mm	63 mm	63 mm
Optional ventilation kit	✓	✓	✓
Colour	StûvGrey	StûvGrey	StûvGrey



Glass

	58	68	78
Width	445 mm	545 mm	645 mm
Height	421 mm	421 mm	421 mm

* Caution: be sure to add the insulation thicknesses defined by your local regulations to the dimensions of the recess.

The appliance must be professionally installed by an authorised dealer/installer.

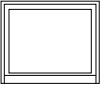
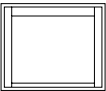
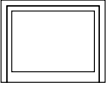
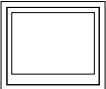

		58	68	78
	Narrow frame 3 sides - 3 mm	W 580 mm	680 mm	780 mm
		H 609 mm	609 mm	609 mm
	Narrow frame 4 sides - 3 mm	W 622 mm	722 mm	822 mm
		H 580 mm	580 mm	580 mm
	Applied frame 3 sides - 50 mm	W 670 mm	770 mm	870 mm
		H 647 mm	647 mm	647 mm
	Applied frame 4 sides - 50 mm	W 684 mm	784 mm	884 mm
		H 638 mm	638 mm	638 mm
	Frame D4	W 1241 mm	1441 mm	1641 mm
		H 579 mm	579 mm	579 mm

Frames

The s16-in frames have been specially designed to create an easy finish between the fireplace and the masonry, whatever your interior requirements.

A pure line



When you choose Stûv, you have a front row seat to the spectacle of fire.

s[16]cube

58

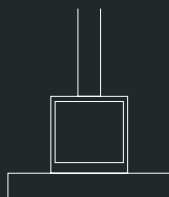

68

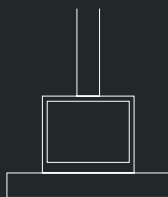

78

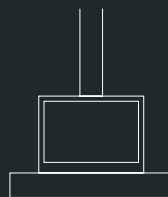

Sober and elegant, the s16-cube can be installed on the dedicated Stûv base or on a custom-made piece of furniture.

Its versatility means it can be integrated into any interior, whether classic, rustic or contemporary.

Performance*

Energy efficiency class

Energy efficiency index

Output

Output range

Nominal efficiency

Seasonal efficiency

Fine particle emissions

CO emissions

NOx emissions

COV/COG emissions

Range of wood consumption

s[16]cube

Logs - Maximum length

Weight

Standards

A	A	A
103	102	99
7 kW	7,5 kW	8 kW
5 - 8 kW	5 - 9 kW	6 - 10 kW
78 %	77 %	75 %
68 %	68 %	65 %
11 mg/Nm ³	19 mg/Nm ³	13 mg/Nm ³
0,09 %	0,10 %	0,09 %
134 mg/Nm ³	117 mg/Nm ³	130 mg/Nm ³
89 mg/Nm ³	59 mg/Nm ³	94 mg/Nm ³
1,4 - 2,3 kg/h	1,5 - 2,6 kg/h	1,8 - 3,0 kg/h



40 cm	50 cm	60 cm
105 kg	113 kg	121 kg
EcoDesign 2022	EcoDesign 2022	EcoDesign 2022

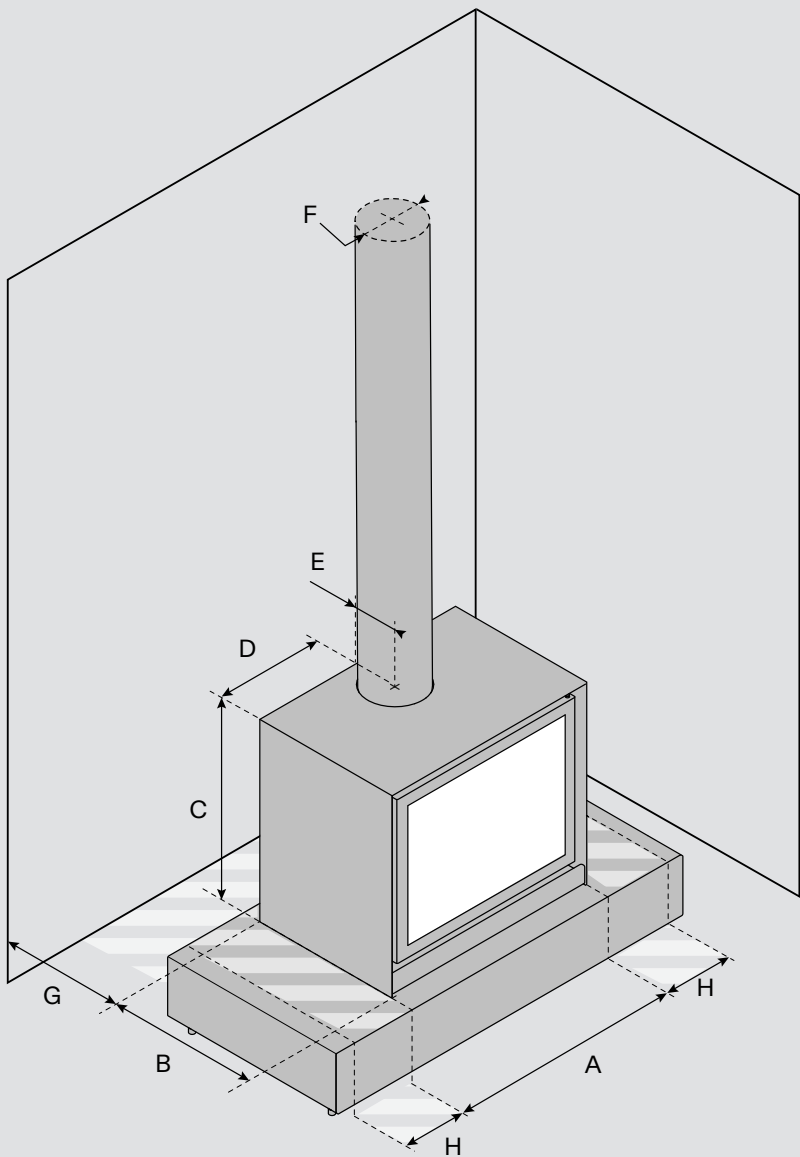

s[16]cube

	58	68	78
[A] Width	580 mm	680 mm	780 mm
[B] Depth	456 mm	456 mm	456 mm
[C] Height	625 mm	625 mm	625 mm
[D] Flue axis - side	290 mm	340 mm	390 mm
[E] Flue axis - rear	130 mm	130 mm	130 mm
[F] Smoke outlet diameter	180 mm	180 mm	180 mm
[G] Minimum rear safety distance	350 mm	300 mm	300 mm
[H] Minimum side clearance	250 mm	150 mm	150 mm
Ø External air connection	63 mm	63 mm	63 mm
Optional ventilation kit	✓	✓	✓
Colour	StûvGrey	StûvGrey	StûvGrey

Glass

	58	68	78
Width	445 mm	545 mm	645 mm
Height	421 mm	421 mm	421 mm



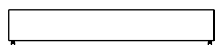

Drawer base

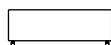

Drawer base



Log cart
with drawer

Width	1200 mm	600 mm	460 mm
Height	210 mm	210 mm	1365 mm
Depth	590 mm	590 mm	590 mm



COLOURS

DarkGrey ●

StûvGrey ●

Concrete Grey ●

White ○

Modular bases

The 3 modular bases are designed to accommodate the s16-cube or store wood. Elegant, simple and practical, they give structure to your fireside and provide additional storage space. The mobile log trolley can be loaded as close as possible to your wood supply.



When you choose Stûv, you benefit from 40 years of expertise and technological innovation.

s[16]up

58

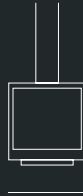

68

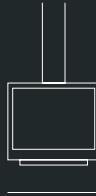

78

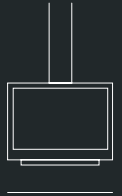

Elegantly suspended, the s16-up magnifies the volume of the room, offering an unobstructed view of the fire.

Thanks to its double combustion system, wood consumption is as economical as it is environmentally friendly.

Performance*

Energy efficiency class

Energy efficiency index

Output

Output range

Nominal efficiency

Seasonal efficiency

Fine particle emissions

CO emissions

NOx emissions

COV/COG emissions

Range of wood consumption

s[16]up

Logs - Maximum length

Weight

Standards

A	A	A
103	102	99
7 kW	7,5 kW	8 kW
5 - 8 kW	5 - 9 kW	6 - 10 kW
78 %	77 %	75 %
68 %	68 %	65 %
11 mg/Nm ³	19 mg/Nm ³	13 mg/Nm ³
0,09 %	0,10 %	0,09 %
134 mg/Nm ³	117 mg/Nm ³	130 mg/Nm ³
89 mg/Nm ³	59 mg/Nm ³	94 mg/Nm ³
1,4 - 2,3 kg/h	1,5 - 2,6 kg/h	1,8 - 3,0 kg/h

58



68



78



40 cm

50 cm

60 cm

113 kg

122 kg

130 kg

EcoDesign 2022

EcoDesign 2022

EcoDesign 2022

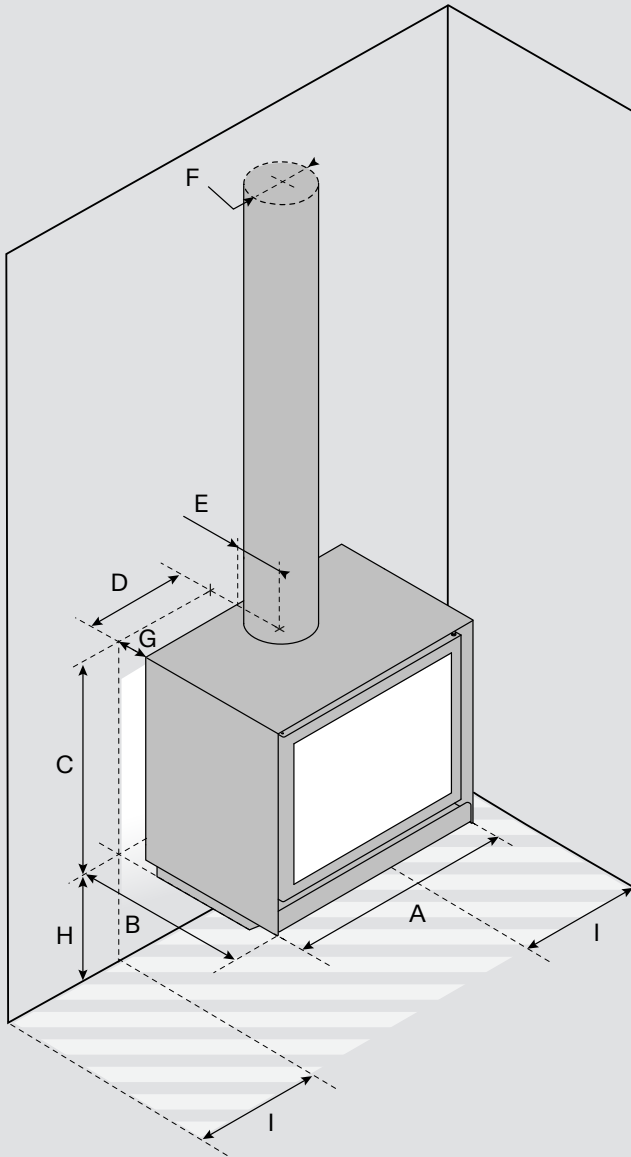

s[16]up

	58	68	78
[A] Width	580 mm	680 mm	780 mm
[B] Depth	506 mm	506 mm	506 mm
[C] Height	678 mm	678 mm	678 mm
[D] Flue axis - side	290 mm	340 mm	390 mm
[E] Flue axis - rear	130 mm	130 mm	130 mm
[F] Smoke outlet diameter	180 mm	180 mm	180 mm
[G] Rear clearance	50 mm	50 mm	50 mm
[H] Lower clearance	330 mm	330 mm	330 mm
[I] Side clearance	250 mm	150 mm	150 mm
Ø External air connection	63 mm	63 mm	63 mm
Optional ventilation kit	-	-	-
Colour	StûvGrey	StûvGrey	StûvGrey

Glass

	58	68	78
Width	445 mm	545 mm	645 mm
Height	421 mm	421 mm	421 mm



A source of
well-being



Choosing Stûv means combining your essential needs with respect for the environment.

s[16]H

58



68



78

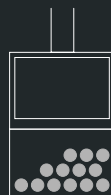

Comprising an s16-cube set on a sleek element, the s16-H stove provides practical, aesthetic storage for logs underneath the appliance.

Identifiable by its vertical height, this model offers the same efficiency and precision of assembly as the s16-cube.

Performance*

Energy efficiency class

Energy efficiency index

Output

Output range

Nominal efficiency

Seasonal efficiency

Fine particle emissions

CO emissions

NOx emissions

COV/COG emissions

Range of wood consumption

s[16]H

Logs - Maximum length

Weight

Standards

A	A	A
103	102	99
7 kW	7,5 kW	8 kW
5 - 8 kW	5 - 9 kW	6 - 10 kW
78 %	77 %	75 %
68 %	68 %	65 %
11 mg/Nm ³	19 mg/Nm ³	13 mg/Nm ³
0,09 %	0,10 %	0,09 %
134 mg/Nm ³	117 mg/Nm ³	130 mg/Nm ³
89 mg/Nm ³	59 mg/Nm ³	94 mg/Nm ³
1,4 - 2,3 kg/h	1,5 - 2,6 kg/h	1,8 - 3,0 kg/h



40 cm

50 cm

50 cm

136 kg

147 kg

158 kg

EcoDesign 2022

EcoDesign 2022

EcoDesign 2022

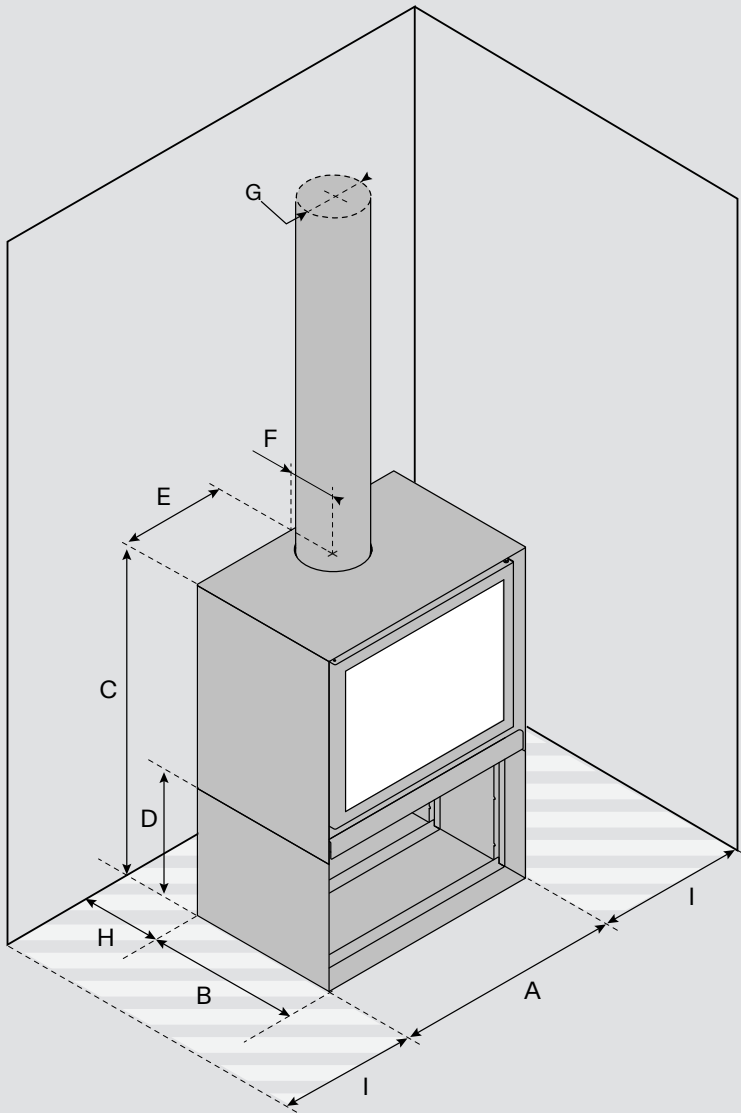

s[16]H

	58	68	78
[A] Width	580 mm	680 mm	780 mm
[B] Depth	456 mm	456 mm	456 mm
[C] Height	1010 mm	1010 mm	1010 mm
[D] Log storage height	400 mm	400 mm	400 mm
[E] Flue axis - side	290 mm	340 mm	390 mm
[F] Flue axis - rear	130 mm	130 mm	130 mm
[G] Smoke outlet diameter	180 mm	180 mm	180 mm
[H] Minimum rear safety distance	350 mm	300 mm	300 mm
[I] Minimum side clearance	250 mm	150 mm	150 mm
Ø External air connection	63 mm	63 mm	63 mm
Floor plate option	✓	✓	✓
Optional ventilation kit	-	-	-
Colour	StûvGrey	StûvGrey	StûvGrey

Glass

	58	68	78
Width	445 mm	545 mm	645 mm
Height	421 mm	421 mm	421 mm





58

68

78

Width	580 mm	680 mm	780 mm
Depth	555 mm	555 mm	555 mm

Floor plate

The floor plate designed for the s16-H protects your floor and makes it easier to maintain. Adapted to each size of stove, it extends the stove and complements its integration into your interior.



Choosing Stûv means keeping the flame of conviviality alive.

s[16]D4

58

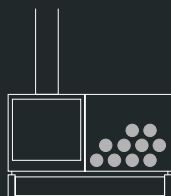

68

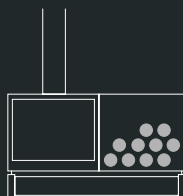

78

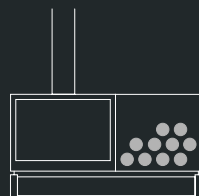

The horizontal combination of stove and wood store creates a serene atmosphere.

Offered on an oak base, this model, available in 3 widths, can also be adapted to other customisable supports.

Performance*

Energy efficiency class

Energy efficiency index

Output

Output range

Nominal efficiency

Seasonal efficiency

Fine particle emissions

CO emissions

NOx emissions

COV/COG emissions

Range of wood consumption



s[16]D4

Logs - Maximum length

Weight

Standards

A	A	A
103	102	99
7 kW	7,5 kW	8 kW
5 - 8 kW	5 - 9 kW	6 - 10 kW
78 %	77 %	75 %
68 %	68 %	65 %
11 mg/Nm ³	19 mg/Nm ³	13 mg/Nm ³
0,09 %	0,10 %	0,09 %
134 mg/Nm ³	117 mg/Nm ³	130 mg/Nm ³
89 mg/Nm ³	59 mg/Nm ³	94 mg/Nm ³
1,4 - 2,3 kg/h	1,5 - 2,6 kg/h	1,8 - 3,0 kg/h

58	68	78
		
40 cm	50 cm	50 cm
219 kg	246 kg	272 kg
EcoDesign 2022	EcoDesign 2022	EcoDesign 2022

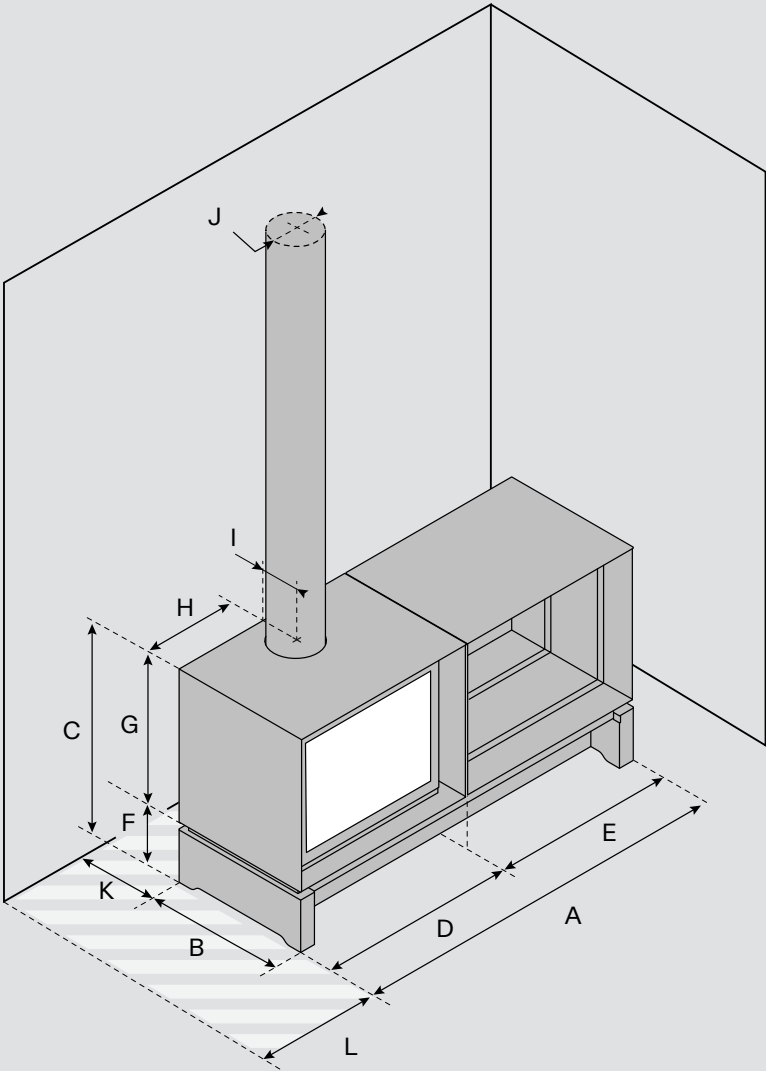

s[16]D4

	58	68	78
[A] Width	1250 mm	1450 mm	1650 mm
[B] Depth	530 mm	530 mm	530 mm
[C] Height	808 mm	808 mm	808 mm
[D] Fireplace width	625 mm	725 mm	825 mm
[E] Niche width	625 mm	725 mm	825 mm
[F] Base height	208 mm	208 mm	208 mm
[G] Fireplace height	600 mm	600 mm	600 mm
[H] Flue axis - side	311 mm	361 mm	411 mm
[I] Flue axis - rear	147 mm	147 mm	147 mm
[J] Smoke outlet diameter	180 mm	180 mm	180 mm
[K] Minimum rear safety distance	350 mm	300 mm	300 mm
[L] Minimum side clearance	250 mm	150 mm	150 mm
Ø External air connection	63 mm	63 mm	63 mm
Optional ventilation kit	-	-	-
Colour	StûvGrey	StûvGrey	StûvGrey

Glass

	58	68	78
Width	445 mm	545 mm	645 mm
Height	421 mm	421 mm	421 mm



Natural
pleasure

REMOVE

FUNCTIONS



s[16]

[SIMPLE] Simplicity is the watchword in the design of this appliance. In terms of design, installation, operation and maintenance.

[POWERFUL] The combustion chamber is lined with vermiculite panels for abundant and immediate heat dispersion. [CLEVER]

An articulated baffle opens when

the door is opened to allow the smoke to escape, preventing a large backdraft into the room.

[RELIABLE] The fully-welded combustion chamber prevents distortion of the metal as the fire burns. [PERFORMANT] Different air injectors ensure a second combustion of the gases. The

process is economical and environmentally friendly: it generates more heat and eliminates as many fine particles as possible from entering the atmosphere. [SAFE] A spring positioned at

the bottom of the door prevents it from remaining open and prevents sparks or embers from falling to the floor. [CLEAN] For an impeccable view of the fire, a stream of air sweeps across

the glass and carries away the dust that comes from combustion. [DURABLE] High-quality materials, precise assembly and a simple shape are just some of the advantages that ensure

its longevity.

The Stûv families

s[6]



s[16]



s[30]



s[μ M]

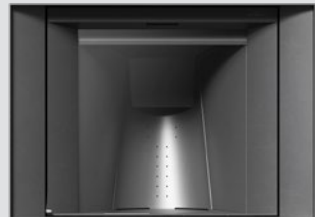

s[21]



s[22]



s[P10]



s[P20]



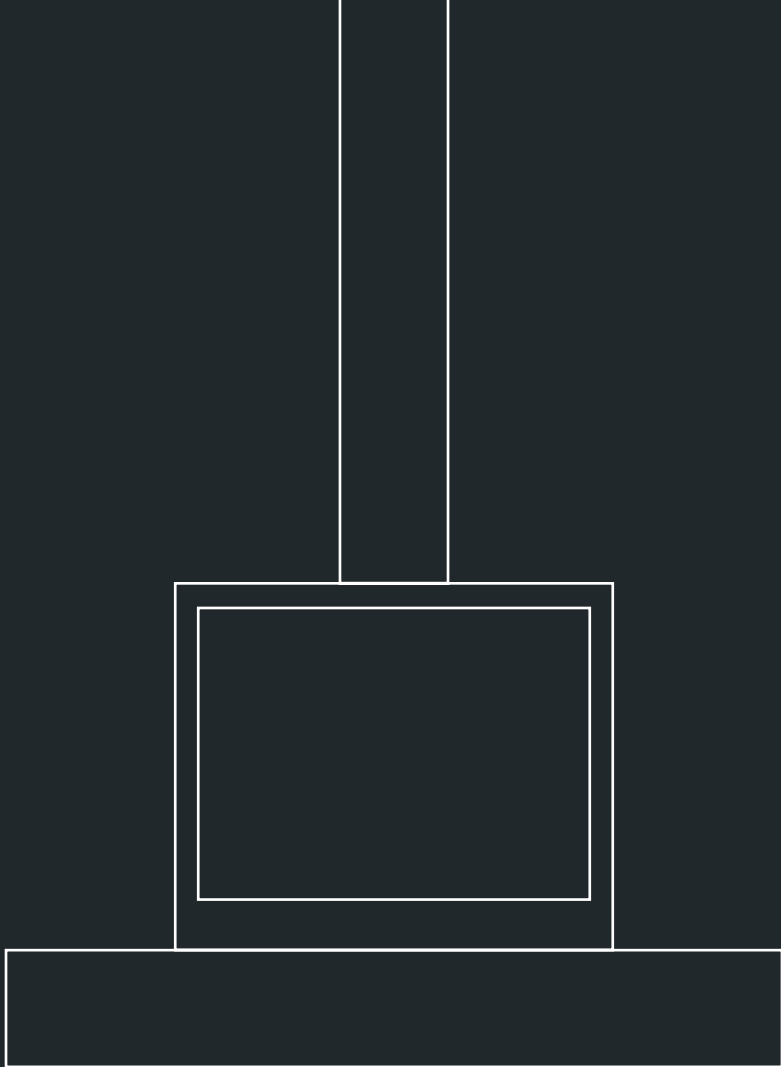

Documents and photos are not contractual. Stûv reserves the right to make changes without notice.
This catalogue has been carefully compiled; however, we decline all responsibility for any errors.

Stûv fireplaces are designed and manufactured by Stûv sa - Belgium - stuv.com